



Three in One:
Gas Meter
Tariff Device
Volume Corrector

Ultrasonic Gas Meter
ECOSONIC X12

ECOSONIC X12 – Values you can count on

The Application Fields

The ultrasonic gas meters of the ECOSONIC X12 series are very precise and robust metering units for measuring the gas flow. The ECOSONIC X12 has been designed from an economical point of view and has been optimized for metering the volume in the natural gas pipelines of energy providers. It has been approved as such by the PTB, the German Standards Department. The metering of bio gases is also foreseen.

The ECOSONIC X12 is a flexible metering unit for use in industry, for transport, as well as the distribution and storage of natural gas.

The ECOSONIC X12 series comprises nominal diameters from DN 80 (3") to DN 300 (12") and a pressure ranges of from PN10 up to ANSI 600 (100bar). Further nominal diameters and pressure ranges are in preparation.

The Advantages

The ECOSONIC X12 offers the typical advantages of the ultrasonic measurement method, inherent to all ultrasonic gas meters:

- no pressure losses
- large measuring ranges (up to 1:100)
- no moving parts, no wear and tear, maintenance-free
- electronic processing of the measured values
- very precise measuring results by using flow correction methods

But the ECOSONIC X12 offers even more:

1 Metering Unit – 3 Functions

The ECOSONIC X12 products contain not “only” an ultrasonic gas meter, but also a volume corrector and a tariff device. Further features:

- an Eco-PT pressure and temperature sensor unit, which is integrated in the casing
- the direct, continuous correction of the metered gas flow
- a continuous recording of data and determination of the peak load
- the unique, ATEX approved operating unit with a touch screen
- optimized transducers, attuned to the electronics, safely installed in the metering unit

Highly integrated

The measured pressure and temperature values are already available while measuring the transit time and are taken into account for the analyses of the flow profile and thus the determination of the flow. This information added to the data of the measuring process results in the following:

- the permanent auto-monitoring of the measuring process from the measuring of the transit time to the correction and the determination of the peak load
- the integrated monitoring of the measuring range, over the entire measuring process
- the active temperature compensation of the flow measurement.



ECOSONIC X12 metering units in the DN 80 (3") and DN 200 (8") versions

The Metering Principle

The ECOSONIC X12 measures the transit time of ultrasonic signals traversing a flow of gas, applying the reliable method of transit time difference calculation. The ultrasonic gas meter determines the velocity of the flowing gas by taking the difference between the ultrasound transit time in the direction of the flow and the transit time in the opposite direction of the flow.

The ECOSONIC X12 measures the transit time to within a few nanoseconds. The casing of the gas meter is manufactured with high precision, the fabrication of the transducers accurate and the knowledge of the dimensions exact, so that reliable metering of the gas volume is guaranteed.

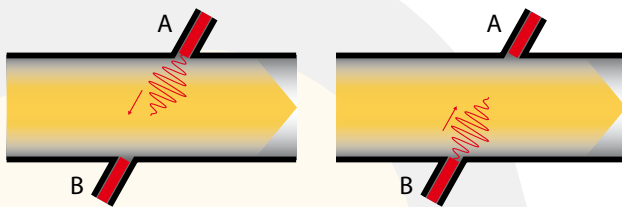

Ultrasonic transducer A transmits in the opposite direction of the flow

Ultrasonic transducer B transmits in the direction of the flow

The Measuring Paths

The ECOSONIC X12 uses six independent measuring paths. These measuring paths are placed on three levels. On each level, there are 2 symmetrical measuring paths which cross.

This arrangement enables the determination of flow factors such as the swirl and asymmetry. The recorded information on the flow profile is redundant.

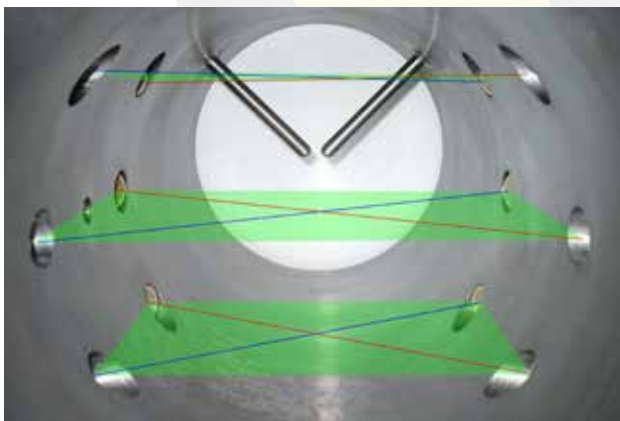

Arrangement of the measuring paths in an ECOSONIC X12 (2 temperature wells in the background)

Ultrasonic Transducers and Electronics

In the development phase, special importance was attached to the optimization of the ultrasonic transducers and the interaction with the electronics.

A variety of optimizations have been obtained by FEA simulations, through the cooperation with distinguished research institutes and our own know-how, together with extensive testing.

The Eco-Touch Control Unit

The innovative Eco-Touch control unit is approved and complies with the ATEX directive. The ECOSONIC X12, together with the Eco-Touch control unit can be used in ATEX zone 1. All values and parameters can be read on the touch screen at the metering point. The most important measuring results are listed on the information page .

The Eco-Touch Display is the reference indication for all measurements and parameters for custody transfer.

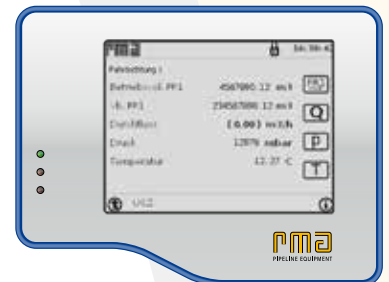



The user guide is structured according to the customary functions of

- ultrasonic gas meters
- volume correctors
- tariff devices
- system functions

and thus follows the usual tried and tested approach. The user interface for operating the unit can be compared with those of mobile phones or PDAs.

The current status of the system is permanently indicated by 3 LEDs.

-  normal operation
-  warning
-  error

Option: Separate Control Unit

The separate Eco-Touch control unit is typically installed with the aid of a wall holder near¹ the metering point, where it can easily be reached and read.

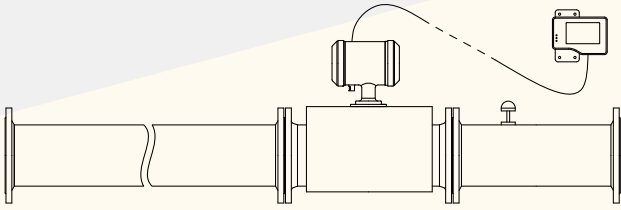

¹ For technical reasons the length of the cable between the metering point and the separate control unit may not exceed 20 m.

Installation Conditions

The unit must be installed at a weatherproof metering point. An inlet pipe of ≥ 10 DN (3/8") in front of the metering unit and an outlet pipe of ≥ 3 DN (1/16") behind it are to be provided. The length of the inlet pipe can be reduced to 5 DN if a flow conditioner is applied.

The gas meter can also be used in a bidirectional mode, the software and user interface have been prepared accordingly.

The details of the dimensioning of the inlet pipe are determined beforehand and verified in comparison with the actual state of the approved configurations, in order to ensure that the metering results are most precise.

Pressure is measured directly in the flow metering unit in between the ultrasonic transducers of every ECOSONIC X12. The temperature measuring point and a second thermowell for functional tests and re-certifications are also always installed as closely as

possible to the flow metering unit. Two thermowells are thus integrated in the metering unit if possible. If such an arrangement is not feasible, one or both temperature wells are installed in the outlet pipe.

The Eco-View Program

The Eco-View diagnostics program is a user friendly application for Windows^{® 2} computers for the control and diagnostics of the ECOSONIC X12. It is connected to the metering unit via the RS 485. The cable length can be up to 500 m or more, depending on the electric environment.



Eco-View shows all measured values and parameters and presents the measured signals and actual measurements in diagrams.

² Windows[®] is a registered trademark of Microsoft Corporation in the United States and other countries

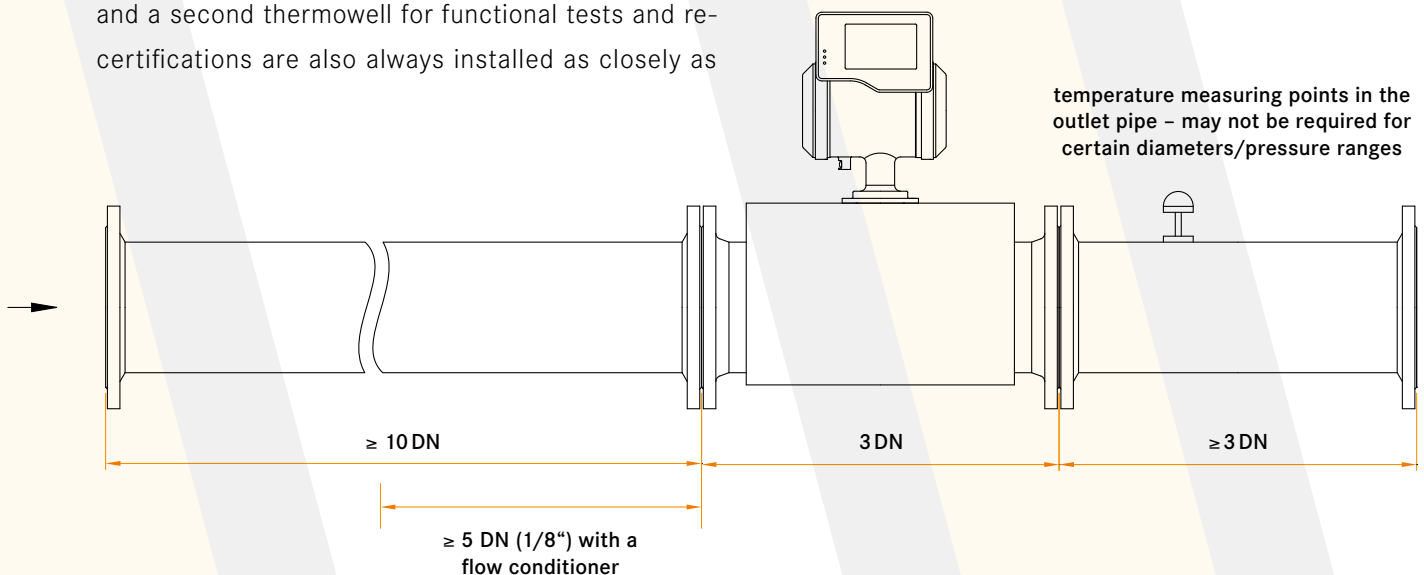

The Volume Corrector

The volume corrector of the ECOSONIC X12 uses tried and tested methods to convert the measured gas volume V_m ("m" for measured) to the billable base volume V_b ("b" for base). The base pressure and temperature values can be configured. In Germany, these values are fixed at 0 °C and $p = 1013.25$ mbar.

The unit converts the metered volume to the base volume on the basis of the measured gas pressure and the temperature of the gas. The increase of the base volume is actually computed for every correction period and the result is added to the meter reading. The correction period can be set to in between 1 and 30 s as required.

The compressibility factor "K" takes the characteristics of natural gases into account for the correction. "K" depends on the pressure, the temperature and the composition of the gas. ECOSONIC X12 can compute "K" according to the following methods:

- constant compressibility factor
- correction according to the GERG 88 standard (3 methods)
- AGA 8 Gross Calculation Method 1, 2
- AGA NX19 mod. BR. corr. 3H

The Tariff Device

The integrated tariff device automatically records the measured volumes and the peak and minimum values in the different periods of time, using a data base-assisted archive of measured values. This archive can be read by the Eco-View software.

The Digital Interfaces

The ECOSONIC X12 is equipped with several digital interfaces.

- manufacturer-independent encoder interface
- modbus interface
- interface for Eco-View

The encoder interface transmits the measured gas volume to external volume correctors or to flow computers. The modbus interface transmits the measuring data to the corresponding applications on other process computers.

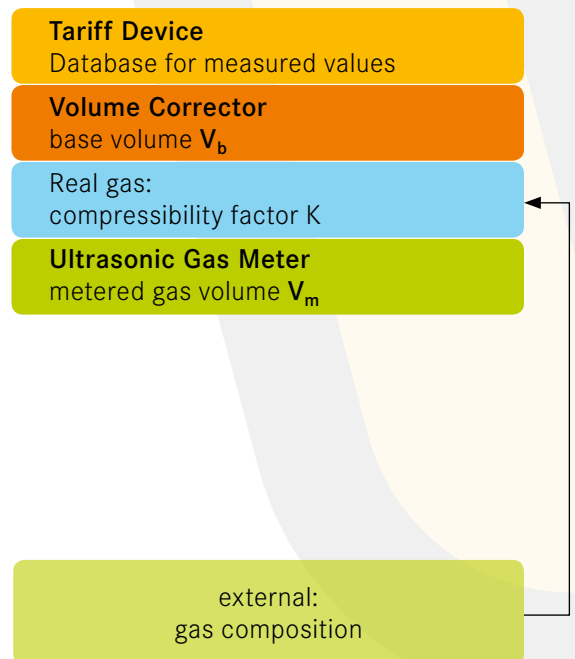
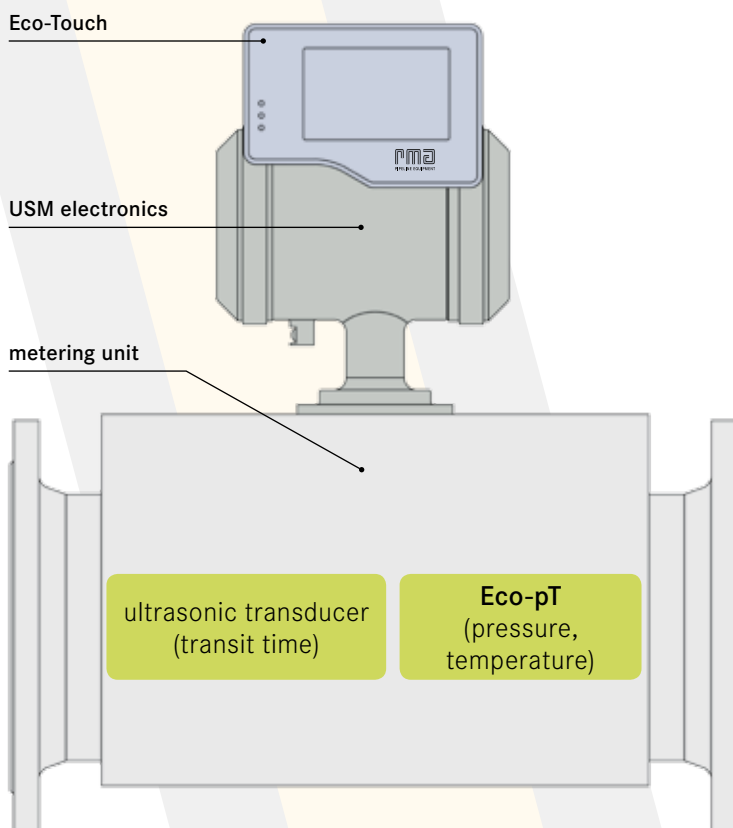

Measuring Ranges

DN [mm]	Qmin [m ³ /h]	Qmax [m ³ /h]	Length L [mm]	Width W [mm]	Height H [mm] (from the centre of the pipe)	max weight [kg]
DN 80 (3")	8	650	240	302	555 (455)	55
DN 100 (4")	10	1000	300	328	585 (463)	90
DN 150 (6")	25	2500	450	403	635 (480)	125
DN 200 (8")	40	4000	600	423	675 (495)	175
DN 250 (10")	65	6500	750	503	745 (532)	280
DN 300 (12")	100	10000	900	553	800 (555)	330

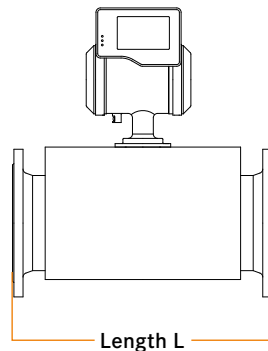
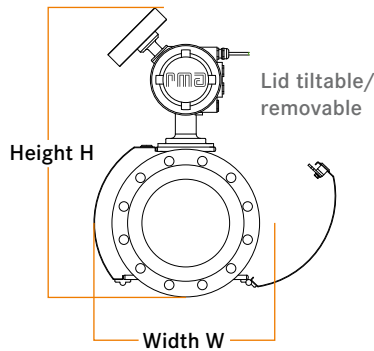

The values given correspond to the typical configurations. Subject to changes. Especially the weight may slightly vary for different pressure ranges.

Specifications

Gas	natural gas, air, gases from the IIB group of gases
Number of measuring paths	6 independent measuring paths on 3 levels
Qmin/Qmax	1:100 (1:80)
Pressure range	max. 100 bar
Accuracy class	1.0 (OIML R 137-1:2006)
Repeatability	< 0.1 % of the measured value
Measurement accuracy	± 0,2 % of the measured value
Measuring cycles	10 independent samples per second and measuring path
Operating voltage	24 V DC
Typical power consumption	≤ 10 W
Gas-/ambient temperature	-25 °C to + 55 °C
Relative air humidity	≥ 10 % ≤ 93 %, condensing (EN 12405-1:2005)
Electr. outputs	2 HF pulse outputs (can be configured) 4 status outputs (can be assigned as required)
Directives	Measuring instruments directive MID 2004/22/EG, Pressure equipment directive 97/23/EG, EMV Directive 89/336/EWG
Explosion protection	according to Directive 94/9/EG (ATEX),  II 2 (2) G Ex d e ib [ib] mb IIB T4 registration number TÜV 09 ATEX 554348 X
IP rating	IP65

Subject to technical changes.

RMA Mess- und Regeltechnik GmbH & Co. KG

Forsthausstraße 3 | D-77866 Rheinau
Telephone +49 (0) 78 44/404-0
Telefax +49 (0) 78 44/404-138
E-Mail mrt@rma-rheinau.de

www.rma-armaturen.de

Germany RMA Kehl GmbH & Co. KG, Kehl
RMA Rheinau GmbH & Co. KG, Rheinau
RMA Training GmbH & Co. KG, Rheinau
France RMA France S.A.S., Bischheim
Poland RMA Polska Sp. z o.o., Chojnów
UK RMA Pipeline Equipment Ltd., Batley
Bahrain RMA Middle East S.P.C, Hidd
Russia RMA OOO Rus, Moscow

PIPELINE EQUIPMENT